

Since 1986
www.yncoupling.com



PIPE COUPLING Technology

YN PIPE COUPLING

YN-coupling is for installing new pipelines coupling and repairing clamp



MULTIEXPANSION S.L.

RECINTO INTERIOR ZONA FRANCA DE CADIZ - EDIFICIO HERACLES - C/ANDORRA NAVE 16L- 11011 CADIZ
TELEFONOS: +34 956 277 129 / +34 630 364 692 - contacto@multiexpansion.es - www.multiexpansion.com



Free from fire risk
Safe

Compared to ordinary pipes
Savings

Short construction period
Economical

Energy-saving
Efficient





Acquired Lloyd's Register Quality Assurance (LRQA) ISO 9001

Korea's first patented product registered with KIPO

- Lloyd's Register's ISO 9001-certified enterprise for the first time in the domestic PIPE COUPLING industry
- Acquired certifications from the world's leading classification societies in eight countries

TYPE APPROVAL CERTIFICATES FOR YN COUPLINGS

(Eight countries that granted class-type approvals)

 (DNV · GL) Norway	 (LR) UK	 (ABS) USA	 (KR) Korea
 (GL) Germany	 (BV) France	 (RMRS) Russia	 (NK) Japan

A technology revolution in PIPE COUPLING for installing new pipelines and repairing bursts!

- ▶ Short construction period
- ▶ Maximum economic benefits from reduced use of raw materials
- ▶ Easy installation and repairs of pipelines
- ▶ Longer product lifespan

PIPE - COUPLINGS



▲ MODEL 1 : GR-S

▲ MODEL 2 : GR-L



▲ MODEL 3 : MF-RS

▲ MODEL 4 : MF-RL



▲ MODEL 5 : RCH-S

▲ MODEL 6 : RCH-L



▲ MODEL 7 : RCD-S

▲ MODEL 8 : RCD-L

NAME OF PARTS

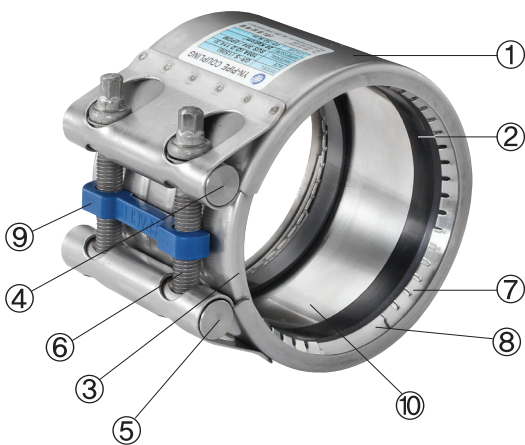

No	Component	Material
1	Case	SUS 304 / SUS 316L
2	Rubber	EPDM Water, air, powder, transfer tube, etc. (-30°C~+90°C)
		NBR Various types of oil and gas transfer tube, etc. (-20°C~+70°C)
		SILICONE High-temperature steam transfer tube, etc. (-50°C~+200°C)
		VITON For high-temperature chemical transfer tube, etc. (-30°C~+230°C)
3	Slide Plate	SUS 304 / SUS 316L
4	Round Bar Washer	SUS 304 / SUS 316L
5	Round Bar Nut	SUS 304 / SUS 316L
6	Bolt	SUS 304 / SUS 316L
7	Grip Ring	SUS 304H / 301H
8	Grip Insert	SUS 304
9	Spacer	Rubber for antilock: orange=NBR, blue=EPDM
10	Insert-Plate	PE, SUS 304(Optional)

*Recommend to using the Insert-Plate when the temperatures of over 40°C or a vacuum line.



GRIP-RING COUPLING (Dimensions)

New Pipes Connector with Axial-Restraint



Model 1 : GR-S
(GRIP RING - STANDARD)



Model 2 : GR-L
(GRIP RING - LONG)

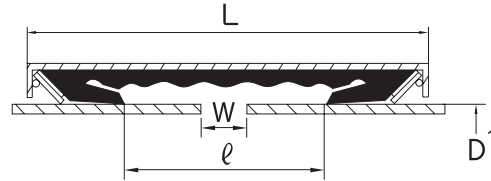
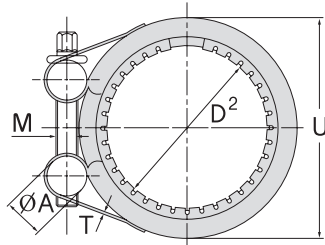

GR-S

※ PIPE O.D. specs are available for all sizes.

Size ND	O/D(mm) D1				Range D2	M	L	ℓ	U	W.P		W.T		P N.m(kgf/cm)
										Industrial	Ship	Industrial	Ship	
15A 1.2"	21.3	21.7	22.0		O/D±0.3	M6 × 40L	57	20	38	40	-	0.2	-	3~5 (30~50)
20A 3/4"	26.9	26.7	27.2		O/D±0.5	M6 × 40L	57	20	47	40	20	0.2	0.2	4~6 (40~60)
25A 1"	33.4	33.7	34.0		O/D±0.6	M6 × 40L	57	20	52	40	20	0.25	0.25	4~6 (40~60)
32A 1-1/4"	42.2	42.4	42.7		O/D±0.6	M8 × 45L	57	20	64	40	20	0.3	0.3	10~12 (100~120)
40A 1-1/2"	40.9	44.5	48.3	48.6	O/D±1.0	M8 × 45L	57	22	68	40	20	0.40	0.40	10~12 (100~120)
50A 2"	54.0	57.0	60.3	60.5	O/D±1.0	M10 × 65L	80	30	84	36	18	0.85	0.85	15~18 (150~180)
65A 2-1/2"	66.7	69.0	73.0	76.3	O/D±1.0	M10 × 65L	80	30	101	36	18	0.90	0.90	15~18 (150~180)
80A 3"	79.8	84.0	88.9	89.1	O/D±1.5	M12 × 75L	108	50	117	32	16	1.5	1.5	40~50 (400~500)
90A 3-1/2"	98.0	101.6			O/D±1.5	M12 × 75L	108	50	142	32	16	1.75	1.7	40~50 (400~500)
100A 4"	106.3	108.0	114.3	118.0	O/D±1.5	M12 × 75L	108	50	142	32	16	1.75	1.7	40~50 (400~500)
125A 5"	129.0	133.0	139.8	141.3	O/D±1.5	M14 × 90L	117	55	176	28	14	2.9	2.9	60~80 (600~800)
150A 6"	154.0	159.0	165.2	168.3	O/D±1.5	M14 × 90L	117	55	201	28	14	3.1	3.1	60~80 (600~800)
200A 8"	204.0	216.3	219.1		O/D±2.0	M16 × 120L	155	72	256	24	12	6.5	10.0	120~150 (1200~1500)
250A 10"	254.0	267.4	273.1		O/D±2.0	M16 × 120L	155	65	300	20	10	7.6	11.0	120~150 (1200~1500)
300A 12"	304.0	318.5	323.9	325.0	O/D±2.0	M18 × 130L	155	65	350	14	7	9.7	13.6	170~190 (1700~1900)
350A 14"	340.0	355.6	377.0	368.0	O/D±2.0	M18 × 130L	155	65	400	14	7	11.4	14.4	170~190 (1700~1900)

GR-L

Size ND	O/D(mm) D1				Range D2	M	L	ℓ	U	W.P		W.T		P N.m(kgf/cm)
										Industrial	Ship	Industrial	Ship	
15A 1.2"	21.3	21.7	22.0		O/D±0.3	M6 × 40L	72	40	39	40	-	0.35	-	3~5 (30~50)
20A 3/4"	26.9	26.7	27.2		O/D±0.5	M6 × 40L	72	40	47	40	-	0.4	-	4~6 (40~60)
25A 1"	33.4	33.7	34.0		O/D±0.6	M8 × 45L	100	55	51	40	20	0.45	0.45	5~8 (50~80)
32A 1-1/4"	42.2	42.4	42.7		O/D±0.6	M8 × 45L	100	55	62	40	20	0.55	0.55	10~12 (100~120)
40A 1-1/2"	40.9	44.5	48.3	48.6	O/D±1.0	M8 × 45L	100	55	66	40	20	0.6	0.6	10~12 (100~120)
50A 2"	54.0	57.0	60.3	60.5	O/D±1.0	M10 × 65L	139	84	81	36	18	1.3	1.3	15~18 (150~180)
65A 2-1/2"	66.7	69.0	73.0	76.3	O/D±1.0	M10 × 65L	139	84	100	36	18	1.4	1.4	15~18 (150~180)
80A 3"	79.8	84.0	88.9	89.1	O/D±1.5	M12 × 75L	203	122	115	32	16	2.9	2.9	40~50 (400~500)
90A 3-1/2"	98.0	101.6			O/D±1.5	M12 × 75L	203	122	144	32	16	3.2	3.2	40~50 (400~500)
100A 4"	106.3	108.0	114.3	118.0	O/D±1.5	M12 × 75L	203	122	144	32	16	3.2	3.2	40~50 (400~500)
125A 5"	129.0	133.0	139.8	141.3	O/D±1.5	M14 × 90L	204	128	175	28	14	4.8	4.8	60~80 (600~800)
150A 6"	154.0	159.0	165.2	168.3	O/D±1.5	M14 × 90L	204	128	196	28	14	5.2	5.2	60~80 (600~800)
200A 8"	204.0	216.3	219.1		O/D±2.0	M16 × 120L	255	157	260	24	12	11.0	16.2	120~150 (1200~1500)
250A 10"	254.0	267.4	273.1		O/D±2.0	M16 × 120L	255	157	300	20	10	12.3	18.4	120~150 (1200~1500)
300A 12"	304.0	318.5	323.9	325.0	O/D±2.0	M18 × 140L	255	157	350	14	7	14.9	21.3	170~190 (1700~1900)

ND: Nominal Diameter (A) ℓ: Allowable Shrinkage/Expansion Clearance (m/m) D1: Actual Outer Diameter of Pipe (m/m) D2: Min./Max. Allowable Limit for Pipe (m/m)
 U: Outer Diameter of Coupling (m/m) M: Fastener Bolt Size/Length (m/m) W.P: Working Pressure (kgf · cm²) W/T: Weight Per Unit (kg)
 L: Coupling Width (m/m) P: Optimum Locking Torque Value Nm (kgf · cm)

※ The specifications are subject to change for quality improvement.



MULTI-FLEX COUPLING (Dimensions)

New Pipes Connector with Non Axial-Restraint



Model 3 : MF-RS
(MULTI-FLEX - ROUND STANDARD)

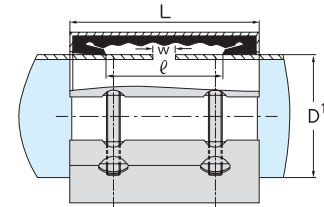
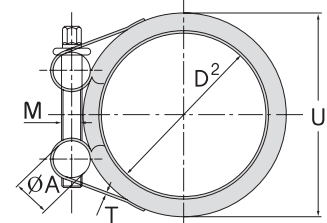

Model 4 : MF-RL
(MULTI-FLEX - ROUND LONG)

MF-RS(15A~5,000A)

※ PIPE O.D. specs are available for all sizes.

Size ND	O/D(mm)			Range D2	M	L	ℓ	U	W.P		W.T		P N.m(kgf/cm)	
	D1								Industrial	Ship	Industrial	Ship		
15A 1.2"	21.3	21.7	22.0	O/D±0.3	M6 × 40L	57	32	37	40	20	0.16	0.16	3~5 (30~50)	
20A 3/4"	26.9	26.7	27.2	O/D±0.5	M6 × 40L	57	32	46	40	20	0.2	0.2	3~5 (30~50)	
25A 1"	33.4	33.7	34.0	O/D±0.6	M6 × 40L	57	32	51	40	20	0.2	0.2	4~6 (40~60)	
32A 1-1/4"	42.2	42.4	42.7	O/D±0.6	M8 × 45L	57	32	62	40	20	0.3	0.3	5~8 (50~80)	
40A 1-1/2"	40.9	44.5	48.3	48.6	O/D±1.0	M8 × 45L	57	32	66	40	20	0.4	0.4	5~8 (50~80)
50A 2"	54.0	57.0	60.3	60.5	O/D±1.0	M10 × 65L	80	46	81	36	18	0.7	0.7	10~12 (100~120)
65A 2-1/2"	66.7	69.0	73.0	76.3	O/D±1.0	M10 × 65L	80	46	100	36	18	0.8	0.8	10~12 (100~120)
80A 3"	79.8	84.0	88.9	89.1	O/D±1.5	M12 × 75L	107	65	115	32	16	1.5	1.5	20~30 (200~300)
90A 3-1/2"	98.0	101.6			O/D±1.5	M12 × 75L	107	65	144	32	16	1.65	1.65	20~30 (200~300)
100A 4"	106.3	108.0	114.3	118.0	O/D±1.5	M12 × 75L	107	65	144	32	16	1.65	1.65	20~30 (200~300)
125A 5"	129.0	133.0	139.8	141.3	O/D±1.5	M14 × 90L	117	71	175	28	14	2.6	2.6	40~50 (400~500)
150A 6"	154.0	159.0	165.2	168.3	O/D±1.5	M14 × 90L	117	71	196	28	14	2.9	2.9	40~50 (400~500)
200A 8"	204.0	216.3	219.1		O/D±2.0	M16 × 120L	155	80	260	24	12	6.4	6.4	60~80 (600~800)
250A 10"	254.0	267.4	273.1		O/D±2.0	M16 × 120L	155	80	300	24	12	6.9	6.9	60~80 (600~800)
300A 12"	304.0	318.5	323.9	325.0	O/D±2.0	M18 × 130L	155	80	350	20	10	8.7	8.7	80~120 (800~1200)
350A 14"	340.0	355.6	377.0	368.0	O/D±2.0	M18 × 130L	155	80	400	20	10	9.5	9.5	80~120 (800~1200)
400A 16"	406.4	414.5	419.0	429.0	O/D±2.5	M18 × 140L	155	94	450	16	-	10.8	-	80~120 (800~1200)
450A 18"	457.2	465.3	480.0		O/D±2.5	M18 × 140L	155	94	500	16	-	11.8	-	80~120 (800~1200)
500A 20"	508.0	516.9	532.0		O/D±3.0	M18 × 140L	155	94	550	14	-	12.6	-	120~150 (1200~1500)

MF-RL

Size ND	O/D(mm)			Range D2	M	L	ℓ	U	W.P		W.T		P N.m(kgf/cm)	
	D1								Industrial	Ship	Industrial	Ship		
15A 1.2"	21.3	21.7	22.0	O/D±0.3	M6 × 40L	72	46	37	40	-	0.35	-	3~5 (30~50)	
20A 3/4"	26.9	26.7	27.2	O/D±0.5	M6 × 40L	72	46	46	40	-	0.4	-	3~5 (30~50)	
25A 1"	33.4	33.7	34.0	O/D±0.6	M8 × 45L	100	64	51	40	20	0.45	0.45	4~6 (40~60)	
32A 1-1/4"	42.2	42.4	42.7	O/D±0.6	M8 × 45L	100	64	62	40	20	0.5	0.5	5~8 (50~80)	
40A 1-1/2"	40.9	44.5	48.3	48.6	O/D±1.0	M8 × 45L	100	64	66	40	20	0.55	0.55	5~8 (50~80)
50A 2"	54.0	57.0	60.3	60.5	O/D±1.0	M10 × 65L	139	99	81	36	18	1.2	1.2	10~12 (100~120)
65A 2-1/2"	66.7	69.0	73.0	76.3	O/D±1.0	M10 × 65L	139	99	100	36	18	1.3	1.3	10~12 (100~120)
80A 3"	79.8	84.0	88.9	89.1	O/D±1.5	M12 × 80L	203	146	115	32	16	2.6	2.6	20~30 (200~300)
90A 3-1/2"	98.0	101.6			O/D±1.5	M12 × 80L	203	146	144	32	16	3.0	3.0	20~30 (200~300)
100A 4"	106.3	108.0	114.3	118.0	O/D±1.5	M12 × 80L	203	146	144	32	16	3.0	3.0	20~30 (200~300)
125A 5"	129.0	133.0	139.8	141.3	O/D±1.5	M14 × 90L	204	138	175	28	14	4.8	4.8	40~50 (400~500)
150A 6"	154.0	159.0	165.2	168.3	O/D±1.5	M14 × 90L	204	138	196	28	14	5.4	5.4	40~50 (400~500)
200A 8"	204.0	216.3	219.1		O/D±2.0	M16 × 120L	255	177	260	24	12	7.0	7.0	60~80 (600~800)
250A 10"	254.0	267.4	273.1		O/D±2.0	M16 × 120L	255	177	300	24	12	11.7	11.7	60~80 (600~800)
300A 12"	304.0	318.5	323.9	325.0	O/D±2.0	M18 × 140L	255	177	350	20	10	15	15.0	80~120 (800~1200)
350A 14"	340.0	355.6	377.0	368.0	O/D±2.0	M18 × 140L	255	170	400	20	10	16.4	16.4	80~120 (800~1200)
400A 16"	406.4	414.5	419.0	429.0	O/D±2.5	M18 × 140L	255	170	450	16	-	18.6	-	80~120 (800~1200)
450A 18"	457.2	465.3	480.0		O/D±2.5	M18 × 140L	255	170	500	16	-	20.4	-	80~120 (800~1200)
500A 20"	508.0	516.9	532.0		O/D±3.0	M18 × 140L	255	170	550	14	-	21.6	-	120~150 (1200~1500)

ND: Nominal Diameter of (A)
 U: Outer Diameter of Coupling (m/m)
 L: Coupling Width (m/m)
 ℓ: Allowable Shrinkage/Expansion Clearance (m/m)
 M: Fastener Bolt Size/Length (m/m)
 P: Optimum Locking Torque Value Nm (kgf · cm)
 D1: Actual Outer Diameter of Pipe (m/m)
 W.P: Working Pressure (kgf · cm2)
 D2: Min./Max. Allowable Limit for Pipe (m/m)
 W/T: Weight Per Unit (kg)

※ The specifications are subject to change for quality improvement.

REPAIR CLAMP HINGE COUPLING (Dimensions)

Pipes Repair Clamp Joints



Model 5 : RCH-S
(REPAIR CLAMP HINGE - STANDARD)

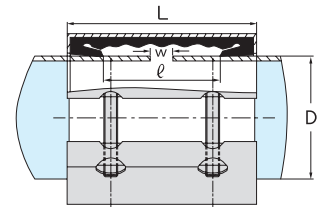
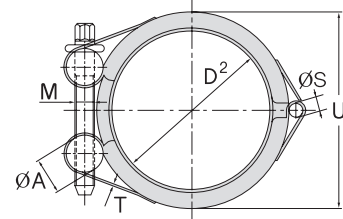
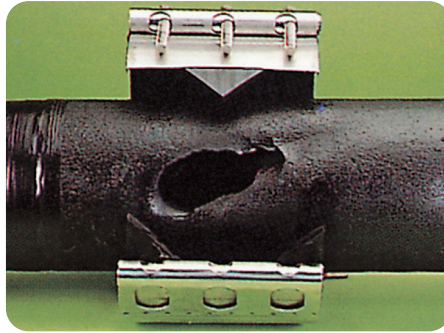

Model 6 : RCH-L
(REPAIR CLAMP HINGE - LONG)

RCH-S (15A~1,000A)

※ PIPE O.D. specs are available for all sizes.

Size ND	O/D(mm)			Range D2	M	L	I	U	W.P	W.T	P N _m (kgf/cm)	
	D1	D1	D1									
15A 1.2"	21.3	21.7	22.0	O/D±0.3	M6 × 40L	57	32	46	18	0.2	3~5 (30~50)	
20A 3/4"	26.9	26.7	27.2	O/D ±0.5	M6 × 40L	57	32	46	18	0.2	3~5 (30~50)	
25A 1"	33.4	33.7	34.0	O/D ±0.6	M6 × 40L	57	32	51	18	0.25	3~5 (30~50)	
32A 1-1/4"	42.2	42.4	42.7	O/D ±0.6	M8 × 50L	57	32	62	18	0.35	4~6 (40~60)	
40A 1-1/2"	40.9	44.5	48.3	48.6	O/D ±1.0	M8 × 50L	57	32	66	18	0.35	4~6 (40~60)
50A 2"	54.0	57.0	60.3	60.5	O/D ±1.0	M10 × 65L	80	46	81	16	0.8	8~10 (80~100)
65A 2-1/2"	66.7	69.0	73.0	76.3	O/D ±1.0	M10 × 65L	80	46	100	16	0.86	8~10 (80~100)
80A 3"	79.8	84.0	88.9	89.1	O/D ±1.5	M12 × 80L	107	65	115	14	1.6	20~25 (200~250)
90A 3-1/2"	98.0	101.6			O/D ±1.5	M12 × 80L	107	65	144	14	1.7	20~25 (200~250)
100A 4"	106.3	108.0	114.3	118.0	O/D ±1.5	M12 × 80L	107	65	144	14	1.7	20~25 (200~250)
125A 5"	129.0	133.0	139.8	141.3	O/D ±1.5	M14 × 100L	117	71	175	12	2.9	30~35 (300~350)
150A 6"	154.0	159.0	165.2	168.3	O/D ±1.5	M14 × 100L	117	71	196	12	3.3	30~35 (300~350)
200A 8"	204.0	216.3	219.1		O/D ±2.0	M16 × 130L	155	80	260	10	6.7	40~50 (400~500)
250A 10"	254.0	267.4	273.1		O/D ±2.0	M16 × 130L	155	80	300	10	7.5	40~50 (400~500)
300A 12"	304.0	318.5	323.9	325.0	O/D ±2.0	M18 × 140L	155	80	350	10	9.0	60~80 (600~800)
350A 14"	340.0	355.6	377.0	368.0	O/D ±2.0	M18 × 140L	155	80	400	10	10.4	60~80 (600~800)
400A 16"	406.4	414.5	419.0	429.0	O/D ±2.5	M18 × 140L	155	94	450	10	11.0	80~100 (800~1000)
450A 18"	457.2	465.3	480.0		O/D ±2.5	M18 × 150L	155	94	500	10	12.8	80~100 (800~1000)
500A 20"	508.0	516.9	532.0		O/D ±3.0	M18 × 150L	155	94	550	10	13.6	100~120 (1000~1200)

RCH-L

Size ND	O/D(mm)			Range D2	M	L	I	U	W.P	W.T	P N _m (kgf/cm)	
	D1	D1	D1									
15A 1.2"	21.3	21.7	22.0	O/D±0.3	M6 × 40L	72	46	46	18	0.35	3~5 (30~50)	
20A 3/4"	26.9	26.7	27.2	O/D ±0.5	M6 × 40L	72	46	46	18	0.4	3~5 (30~50)	
25A 1"	33.4	33.7	34.0	O/D ±0.6	M8 × 50L	100	64	51	18	0.5	3~5 (30~50)	
32A 1-1/4"	42.2	42.4	42.7	O/D ±0.6	M8 × 50L	100	64	62	18	0.6	4~6 (40~60)	
40A 1-1/2"	40.9	44.5	48.3	48.6	O/D ±1.0	M8 × 50L	100	64	66	18	0.65	4~6 (40~60)
50A 2"	54.0	57.0	60.3	60.5	O/D ±1.0	M10 × 65L	139	99	81	16	1.4	8~10 (80~100)
65A 2-1/2"	66.7	69.0	73.0	76.3	O/D ±1.0	M10 × 65L	139	99	100	16	1.5	8~10 (80~100)
80A 3"	79.8	84.0	88.9	89.1	O/D ±1.5	M12 × 80L	203	146	115	14	3.0	20~25 (200~250)
90A 3-1/2"	98.0	101.6			O/D ±1.5	M12 × 80L	203	146	144	14	3.3	20~25 (200~250)
100A 4"	106.3	108.0	114.3	118.0	O/D ±1.5	M12 × 80L	203	146	144	14	3.3	20~25 (200~250)
125A 5"	129.0	133.0	139.8	141.3	O/D ±1.5	M14 × 100L	204	138	175	12	5.1	30~35 (300~350)
150A 6"	154.0	159.0	165.2	168.3	O/D ±1.5	M14 × 100L	204	138	196	12	5.7	30~35 (300~350)
200A 8"	204.0	216.3	219.1		O/D ±2.0	M16 × 130L	255	177	260	10	11.8	40~50 (400~500)
250A 10"	254.0	267.4	273.1		O/D ±2.0	M16 × 130L	255	177	300	10	13.1	40~50 (400~500)
300A 12"	304.0	318.5	323.9	325.0	O/D ±2.0	M18 × 140L	255	177	350	10	13.5	60~80 (600~800)
350A 14"	340.0	355.6	377.0	368.0	O/D ±2.0	M18 × 140L	255	170	400	10	18.2	60~80 (600~800)
400A 16"	406.4	414.5	419.0	429.0	O/D ±2.5	M18 × 140L	255	170	450	10	19.6	80~100 (800~1000)
450A 18"	457.2	465.3	480.0		O/D ±2.5	M18 × 150L	255	170	500	10	21.0	80~100 (800~1000)
500A 20"	508.0	516.9	532.0		O/D ±3.0	M18 × 150L	255	170	550	10	23.0	100~120 (1000~1200)

ND: Nominal Diameter (A)

ℓ: Allowable Shrinkage/Expansion Clearance (m/m)

D1: Actual Outer Diameter of Pipe (m/m)

D2: Min./Max. Allowable Limit for Pipe (m/m)

U: Outer Diameter of Coupling (m/m)

M: Fastener Bolt Size/Length (m/m)

W.P: Working Pressure (kgf · cm²)

W/T: Weight Per Unit (kg)

L: Coupling Width (m/m)

P: Optimum Locking Torque Value Nm (kgf · cm)

※ The specifications are subject to change for quality improvement.

CLAMP DOUBLE LOCK COUPLING (Dimensions)

Pipes Split Clamp Joints



Model 7 : RCD-S
(REPAIR CLAMP DOUBLE LOCK - STANDARD)



Model 8 : RCD-L
(REPAIR CLAMP DOUBLE LOCK - LONG)

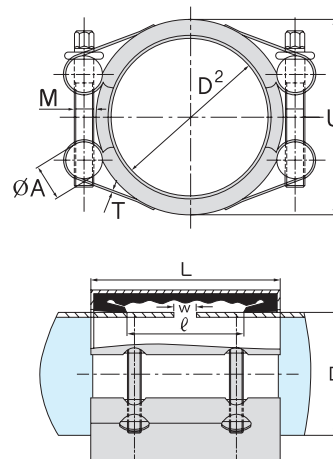

RCD-S(20A~5,000A)

※ PIPE O.D. specs are available for all sizes.

Size ND	O/D(mm)				Range D2	M	L	I	U	W.P	W.T	P N.m(kgf/cm)
	D1											
20A 3/4"	26.9	26.7	27.2		O/D ±0.5	M6 × 40L	57	32	46	20	0.3	3~5 (30~50)
25A 1"	33.4	33.7	34.0		O/D ±0.6	M6 × 40L	57	32	51	20	0.3	3~5 (30~50)
32A 1-1/4"	42.2	42.4	42.7		O/D ±0.6	M8 × 45L	57	32	62	20	0.5	5~10 (50~100)
40A 1-1/2"	40.9	44.5	48.3	48.6	O/D ±1.0	M8 × 45L	57	32	66	20	0.6	5~10 (50~100)
50A 2"	54.0	57.0	60.3	60.5	O/D ±1.0	M10 × 55L	80	46	81	18	1.1	10~15 (100~150)
65A 2-1/2"	66.7	69.0	73.0	76.3	O/D ±1.0	M10 × 55L	80	46	100	18	1.2	10~15 (100~150)
80A 3"	79.8	84.0	88.9	89.1	O/D ±1.5	M12 × 65L	107	65	115	16	2.1	20~30 (200~300)
100A 4"	106.3	108.0	114.3	118.0	O/D ±1.5	M12 × 65L	107	65	144	16	2.3	20~30 (200~300)
125A 5"	129.0	133.0	139.8	141.3	O/D ±1.5	M14 × 80L	117	71	175	14	3.6	40~50 (400~500)
150A 6"	154.0	159.0	165.2	168.3	O/D ±1.5	M14 × 80L	117	71	196	14	3.9	40~50 (400~500)
200A 8"	204.0	216.3	219.1		O/D ±2.0	M16 × 100L	155	80	260	12	8.7	60~80 (600~800)
250A 10"	254.0	267.4	273.1		O/D ±2.0	M16 × 100L	155	80	300	12	9.4	60~80 (600~800)
300A 12"	304.0	318.5	323.9	325.0	O/D ±2.0	M18 × 120L	155	80	350	10	11.9	80~120 (800~1200)
350A 14"	340.0	355.6	377.0	368.0	O/D ±2.0	M18 × 120L	155	80	400	10	12.4	80~120 (800~1200)
400A 16"	406.4	414.5	419.0	429.0	O/D ±2.5	M18 × 120L	155	94	450	10	14.3	80~120 (800~1200)
450A 18"	457.2	465.3	480.0		O/D ±2.5	M18 × 130L	155	94	500	10	14.8	80~120 (800~1200)
500A 20"	508.0	516.9	532.0		O/D ±3.0	M18 × 130L	155	94	550	10	15.9	120~150 (1200~1500)

RCD-L

Size ND	O/D(mm)				Range D2	M	L	I	U	W.P	W.T	P N.m(kgf/cm)
	D1											
25A 1"	33.4	33.7	34.0		O/D ±0.6	M8 × 45L	100	64	51	20	0.7	3~5 (30~50)
32A 1-1/4"	42.2	42.4	42.7		O/D ±0.6	M8 × 45L	100	64	62	20	0.8	5~10 (50~100)
40A 1-1/2"	40.9	44.5	48.3	48.6	O/D ±1.0	M8 × 45L	100	64	66	20	0.85	5~10 (50~101)
50A 2"	54.0	57.0	60.3	60.5	O/D ±1.0	M10 × 55L	139	99	81	18	1.8	10~15 (100~150)
65A 2-1/2"	66.7	69.0	73.0	76.3	O/D ±1.0	M10 × 55L	139	99	100	18	1.9	10~15 (100~150)
80A 3"	79.8	84.0	88.9	89.1	O/D ±1.5	M12 × 65L	203	146	115	16	3.9	20~30 (200~300)
100A 4"	106.3	108.0	114.3	118.0	O/D ±1.5	M12 × 65L	203	146	144	16	4.3	20~30 (200~300)
125A 5"	129.0	133.0	139.8	141.3	O/D ±1.5	M14 × 80L	204	138	175	14	6.5	40~50 (400~500)
150A 6"	154.0	159.0	165.2	168.3	O/D ±1.5	M14 × 80L	204	138	196	14	7.1	40~50 (400~500)
200A 8"	204.0	216.3	219.1		O/D ±2.0	M16 × 100L	255	177	260	12	15.3	60~80 (600~800)
250A 10"	254.0	267.4	273.1		O/D ±2.0	M16 × 100L	255	177	300	12	16.3	60~80 (600~800)
300A 12"	304.0	318.5	323.9	325.0	O/D ±2.0	M18 × 120L	255	177	350	10	20.1	80~120 (800~1200)
350A 14"	340.0	355.6	377.0	368.0	O/D ±2.0	M18 × 120L	255	170	400	10	22.9	80~120 (800~1200)
400A 16"	406.4	414.5	419.0	429.0	O/D ±2.5	M18 × 120L	255	170	450	10	24.0	80~120 (800~1200)
450A 18"	457.2	465.3	480.0		O/D ±2.5	M18 × 130L	255	170	500	10	25.8	80~120 (800~1200)
500A 20"	508.0	516.9	532.0		O/D ±3.0	M18 × 130L	255	170	550	10	26.5	120~150 (1200~1500)

ND: Nominal Diameter (A) ℓ: Allowable Shrinkage/Expansion Clearance (m/m) D1: Actual Outer Diameter of Pipe (m/m) D2: Min./Max. Allowable Limit for Pipe (m/m)
 U: Outer Diameter of Coupling (m/m) M: Fastener Bolt Size/Length (m/m) W.P.: Working Pressure (kgf · cm²) W/T: Weight Per Unit (kg)
 L: Coupling Width (m/m) P: Optimum Locking Torque Value Nm (kgf · cm)

※ The specifications are subject to change for quality improvement.

FPC-GRIP RING COUPLING (Dimensions)

Fire Protection Cover with Axial-Restraint



▲ The product just before the fire test, after being installed in a furnace



▲ The product during the fire test according to ISO 19922 regulation



▲ The product after completion of the test with normal pressure being maintained at over 800°C

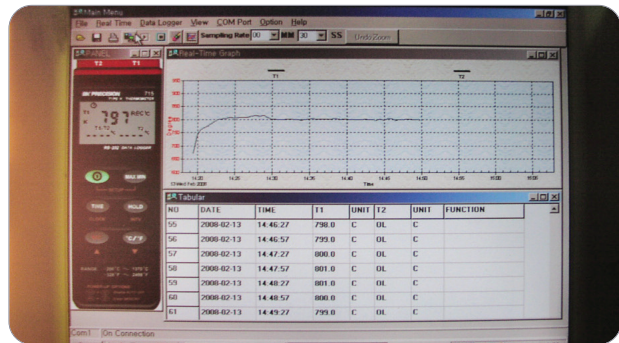

▲ The product with flame temperature being maintained at over 800°C

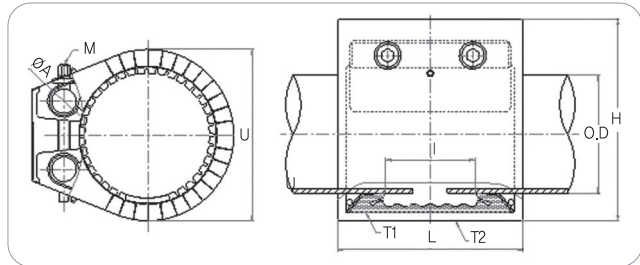

▲ The product with absolutely no internal structure problems after the test.

FPC-GR-S

Size ND	O/D(mm)				Range D2	M	L	I	U	H	W.P	W.T	P N, m(kgf/cm)
	D1												
20A 3/4"	26.9	26.7	27.2		O/D ±0.5	M6 × 40L	68	20	52	63	20	0.32	5~8
25A 1"	33.4	33.7	34.0		O/D ±0.6	M6 × 40L	68	20	59	70	20	0.35	5~8
32A 1-1/4"	42.2	42.4	42.7		O/D ±0.6	M8 × 45L	68	20	68	81	20	0.45	10~15
40A 1-1/2"	40.9	44.5	48.3	48.6	O/D ±1.0	M8 × 45L	68	22	73	87	20	0.5	10~15
50A 2"	54.0	57.0	60.3	60.5	O/D ±1.0	M10 × 65L	94	32	92	109	18	1.0	15~20
65A 2-1/2"	66.7	69.0	73.0	76.3	O/D ±1.0	M10 × 65L	94	30	108	124	18	1.2	15~20
80A 3"	79.8	84.0	88.9	89.1	O/D ±1.5	M12 × 75L	122	50	130	144	16	2.1	40~50
90A 3-1/2"	98.0	101.6			O/D ±1.5	M12 × 75L	122	50	155	171	16	2.4	40~50
100A 4"	106.3	108.0	114.3	118.0	O/D ±1.5	M12 × 75L	122	50	155	171	16	2.4	40~50
125A 5"	129.0	133.0	139.8	141.3	O/D ±1.5	M14 × 90L	138	55	182	203	14	3.8	90~100
150A 6"	154.0	159.0	165.2	168.3	O/D ±1.5	M14 × 90L	138	55	207	229	14	4.2	90~100
200A 8"	204.0	216.3	219.1		O/D ±2.0	M16 × 130L	176	72	265	297	12	11.2	120~150
250A 10"	254.0	267.4	273.1		O/D ±2.0	M16 × 130L	176	63	316	348	10	12.9	120~150
300A 12"	304.0	318.5	323.9	325.0	O/D ±2.0	M18 × 130L	176	70	367	400	7	14.9	170~190
350A 14"	340.0	355.6	377.0	368.0	O/D ±2.0	M18 × 130L	176	68	404	439	7	16.1	170~190

ND: Nominal Diameter (A)

U: Allowable Shrinkage/Expansion Clearance (m/m)

D1: Actual Outer Diameter of Pipe (m/m)

D2: Min./Max. Allowable Limit for Pipe (m/m)

U: Outer Diameter of Coupling (m/m)

M: Fastener Bolt Size/Length (m/m)

W.P: Working Pressure (kgf · cm²)

W/T: Weight Per Unit (kg)

L: Coupling Width (m/m)

P: Optimum Locking Torque Value Nm (kgf · cm)

H: Height Per Unit (mm)

YN-COUPLING NEW MODELS

WIDE LENGTH MODELS



YN - COUPLING
RCD - L3
(Width 300mm)
300A~3,000A



YN - COUPLING
RCD - L5
(Width 500mm)
500A~4,000A



YN - COUPLING
RCD - L7
(Width 700mm)
800A~5,000A

▲ Remark Y.N COUPLING Length(mm) (L:300, L:500, L700 Available by order)

▶ Scene of testing perfect torsional functions

Misaligned Pipes Connecting Test Report

Tested and Reported by Lee, Dongwoo / 22 Aug 2011

A. Test Condition

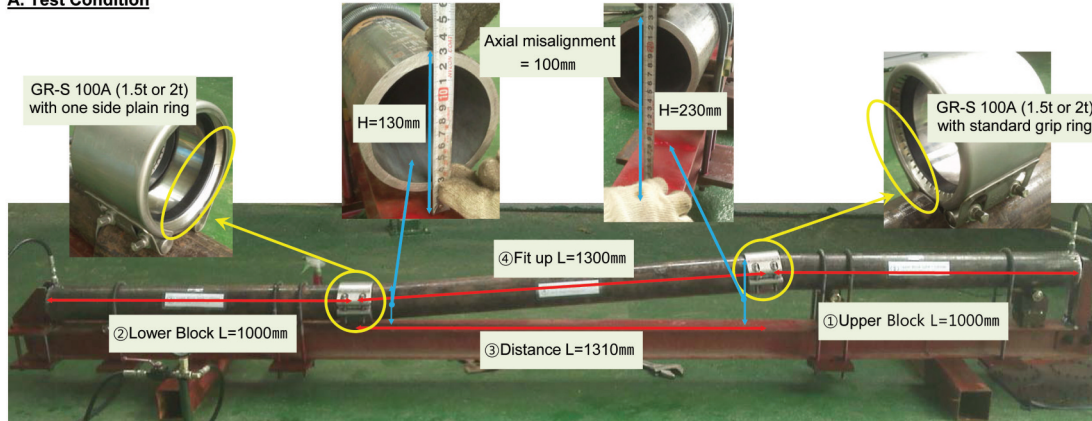

B. Test Result

a. GR-S 100A

/Case thickness 2mm
Torque : 50N-m
Test Pressure : 8.0MPa
Holding Time : 30min.
Deformation : None
Remark :
Not tested over 8.0MPa



b. GR-S 100A

/Case thickness 1.5mm
Torque : 50N-m
Test Pressure : 6.0MPa
Holding Time : 30min.
Deformation : None
Remark :
The coupling case starts inflating at 6.5MPa.
And it has leaked at 7.0MPa.

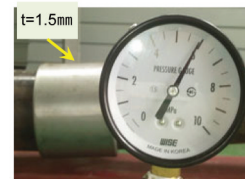

Quality Assurance Department

YOUNG NAM METAL CO., LTD.

OPERATING PRINCIPLES AND INSTALLATION

Application for Pipe

Because the protrusion of the inner sealing, devised by special principles to accurately maintain pressure in a tight state inside, assures semi-permanent life, and the LIP in the shape of lips keeps the contents flowing into the inside absolutely watertight under any circumstances, leaks are guaranteed to be practically nil. In particular, the length of product MODEL RL (ROUND LONG) is 1.6~1.8 times longer than MODEL RS (ROUND STANDARD), and therefore its use is concentrated in places where shrinkage and expansion are frequent. In the diagram, the dot-ted lines leading up to the arrows represent the function that allows the maximum shrinkage and expansion. (If both sides of the pipe are not fixed in place when using the MF-RSIMF-RL Type, it is highly likely that the pipe will be pulled out due to pressure inside the pipe.)

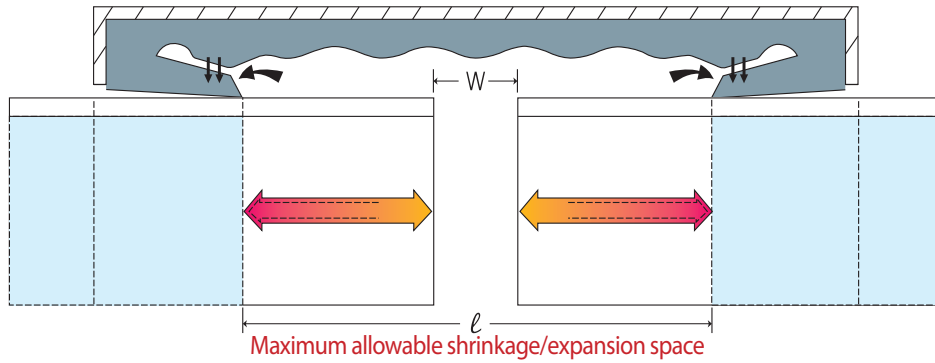

YN - PIPE COUPLING CONNECTION GUIDE

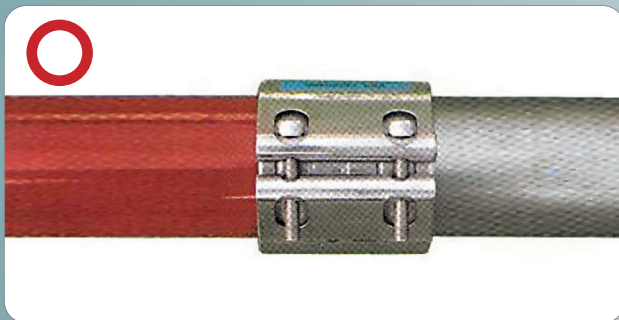

▲MULTI - FLEX COUPLING

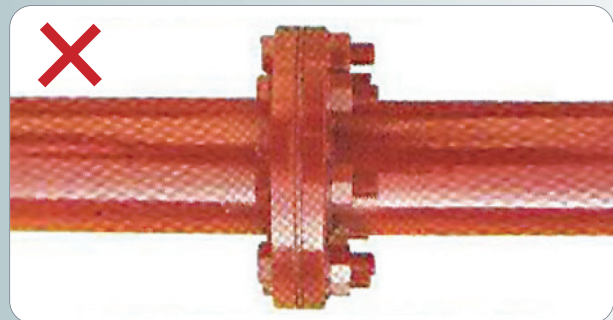

▲FLANGE

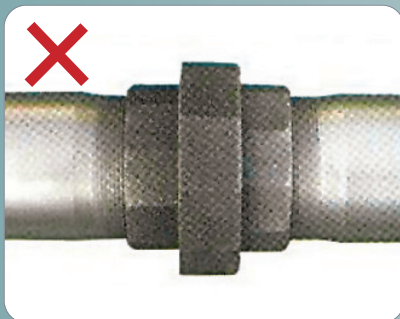

▲UNION

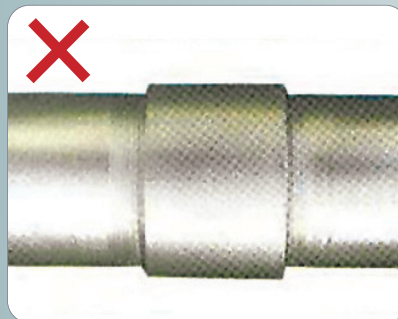

▲SOCKET



▲WELDING

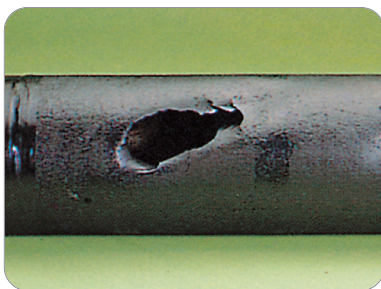

▲DAMAGED PIPES

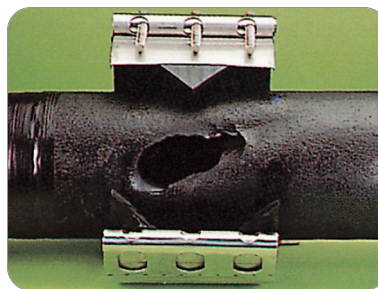

▲REPAIRING THE PIPES

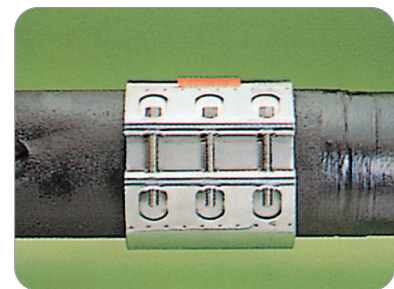

▲COMPLETED THE REPAIRING

TEST SPECIFICATION OF PIPE COUPLING

Test Method : IACS Req. 2001 /Rev.3 2012

Test Item		Socket Joint		Test Method												
		GRTYPE	MFTYPE													
1	Tightness Test	Applied	Applied	Connect a mechanical joint in the space between pipes, pressurize it with a pressure 1.5 times the design pressure and maintain it for 5 minutes. PASS if it is leak free.												
2	Vibration Test	Applied	-	<p>Perform the three tests on the pipe connected to a mechanical joint by maintaining design pressure. PASS only if all three tests prove to be leak free.</p> <table border="1"> <thead> <tr> <th>Number of cycle</th> <th>Amplitude, mm</th> <th>Frequency, Hz</th> </tr> </thead> <tbody> <tr> <td>3×10⁶</td> <td>±0.06</td> <td>100</td> </tr> <tr> <td>3×10⁶</td> <td>±0.5</td> <td>45</td> </tr> <tr> <td>3×10⁶</td> <td>±1.5</td> <td>10</td> </tr> </tbody> </table>	Number of cycle	Amplitude, mm	Frequency, Hz	3×10 ⁶	±0.06	100	3×10 ⁶	±0.5	45	3×10 ⁶	±1.5	10
Number of cycle	Amplitude, mm	Frequency, Hz														
3×10 ⁶	±0.06	100														
3×10 ⁶	±0.5	45														
3×10 ⁶	±1.5	10														
3	Pressure Pulsation Test	Applied	-	A test to check whether an assembly with mechanical joints can withstand pressure pulsation. Increase the impact pressure to 1.5 times the design pressure from zero within a frequency range of 30~ 50 cycles per minute, with the number of cycles being over 500,000, and check for any leaks or signs of fault. PASS only if no faults are detected.												
4	Burst Pressure Test	Applied	Applied	A test intended to check whether an assembly that passed a watertight test can withstand a burst pressure four times the design pressure. PASS only if it is leak free even when the foregoing pressure is applied.												
5	Pull-Out Test	Applied	-	<p>When the load pressurized up to the design pressure and calculated by the following equation is applied to an assembly in the direction of axial load to verify that the assembly with a mechanical joint is not separated from the connected pipe under the axial load that can be generated while the assembly is in use. It must be leak free to be declared as PASS.</p> $L = \frac{\pi}{4} \cdot D^2 \cdot P$ <p>(Axial Load) (Tube Size) (W/Pressure)</p>												
6	Fire Test	Applied	Applied	Expose an assembly with a mechanical joint to a flame at 800°C dml for 30 minutes in a state where water is in circulation at over 80% under the design pressure of a joint. (Have the flame envelop the test material.) PASS only if there is no leak.												
7	Vacuum Test	Applied	Applied	Connect the assembly that has a mechanical joint to a vacuum pump to make the pressure 170hPa (absolute pressure). If the pressure is stabilized, separate the vacuum pump from the assembly with a mechanical joint being tested and keep it in this condition for 5 minutes. PASS only if no fault occurs in this state.												
8	Repeated Assembly Test	Applied	-	Combine and separate the test material with a mechanical joint 10 times according to the manufacturer's instructions and carry out the prescribed watertight test. PASS if there is no leak.												

TEST DATA FOR PIPE COUPLING

Various Test Methods

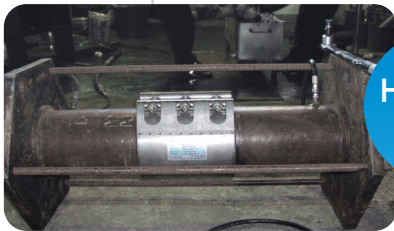

Hydraulic Test

Product Name	Test Pressure	Test Result	Final Hydraulic Test Result
MF-RL 100A	14kgf/cm ²	Maintained for 5 minutes. Normal	Result of 64kgf/cm ² hydraulic test; Normal

※See P.11

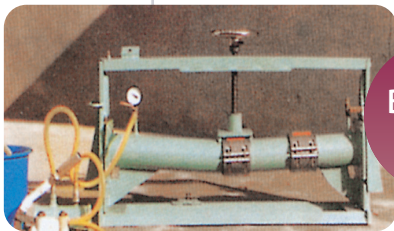

Bending Test

Product Name	Test Pressure	Final Bending Angle	Result
MF-RS 100A	30kgf/cm ²	Both sides 6°	Normal

(15mm Misaligned)

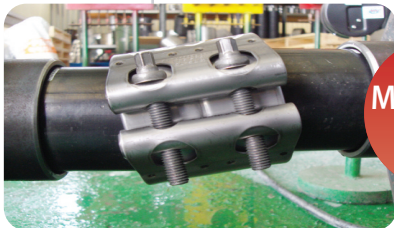

Misaligned Test

Product Name	Working Pressure (MPa)	Test Pressure (MPa)	Burst Pressure (MPa)
GR-S 65A	2.4	3.6	4.3

Pressure Pulsation Test

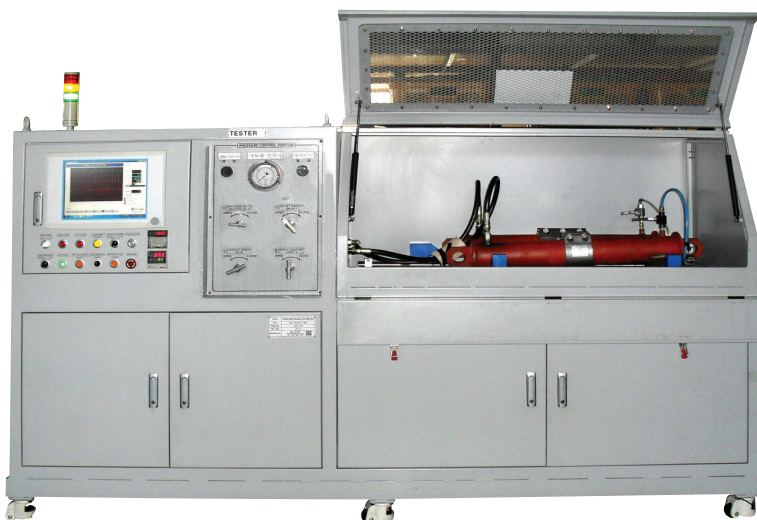

Pressure Recording

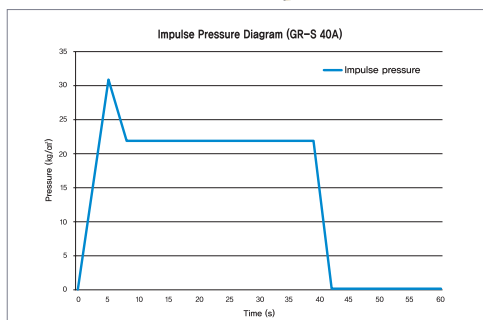

GR-S		GR-L	
Size	Cycles	Size	Cycles
40A	500,000	40A	500,000
100A	500,000	100A	500,000
200A	500,000	200A	500,000

※See P.11

◀ Impulse Pressure Diagram

TEST DATA FOR Y.N GRIP RING PIPE COUPLING

Test Report

PULL OUT LOAD TEST (See P. 11)



GR-S		GR-L	
Size	LOAD(TON)	Size	LOAD(TON)
40A	0.4	40A	0.4
100A	1.7	100A	1.7
200A	4.5	200A	4.5

Test Administration Agency : Safety Economy Engineering

Test Name: Vibration Test, Pressure Test, Vacuum Test

● Vibration Test Method (See P. 11)

Vibration Time	NO OF CYCLES	AMPLITUDE (mm)	FREQUENCY	Result
Repeat Sequence	3×10 ⁶	± 0.06 ± 0.5 ± 1.5	100 45 10	Satisfactory

● Pressure Test Method (See P. 11)

Pressure test during vibration test	32kgf/cm ² (Pressure twice as high as working pressure)	Result: Satisfactory
-------------------------------------	---	----------------------

● Vacuum Test (Time) (See P. 11)

Vacuum Test	Vacuum Test Pressure : 170mbar	Result: Satisfactory
-------------	--------------------------------	----------------------

Test Administration Agency : Korea Maritime Equipment Research Institute

Scene of vibration tests (simultaneously conducted)

Test Administration Agency: Changwon Techno-Park Equipment Research Institute

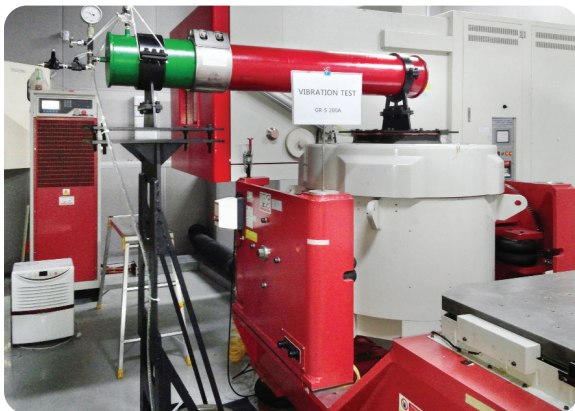

Test Details: Simultaneous performance of the above

Scene of Fire Test (Flame Test)



Test Details : A fire resistance test was conducted for 30 minutes at 800°C. (Pressure of 18kgf/cm² maintained)

Test Regulations : ISO 19921, ISO 19922

PIPE COUPLING SITE APPLICATION

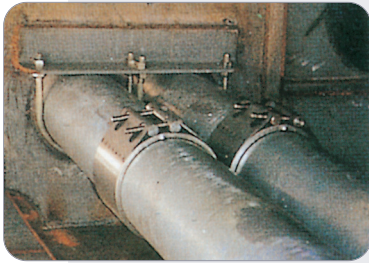

Applications for the shipbuilding industry

Firefighting lines, plumbing, ballast, sanitary, compressed air, cooling water systems, seawater, fresh water, drains, soundings, electric cable protection, oil transfer, and fuel oil lines, MULTI-FLEX, GRIP RING PIPE COUPLINGS are used in a wide range of applications. They have front and back, left and right torsions in the calibrated part of the center line. For places with a high noise level, they guarantee various useful functions, such as a 30% lighter weight than the general flange connection process. In particular, the long-sized coupling, with its long attachment length, is an innovative product for the shipbuilding industry, where severe vibration, shrinkage, and expansion commonly occur.



For gas supply and piping for district heating works

Gas pipes and dual-pipes for heating works are mostly welded; however, such a welding process has its drawbacks: the weld zone requires ultra-precision welding technology, and if a fault about the size of the eye of a needle develops, gas and warm water is sure to continue to leak underground, thereby causing fatigue phenomena, soft ground, and excessive load. We are justly proud that this product is the only solution to prevent a major accident arising from such factors, particularly with respect to pipes buried underground.

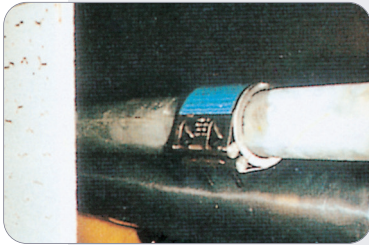

Piping for heavy industry

As it is used annually for repairs to cold and warm water pump lines and LPG, LNG, and GAS pipelines, its cost efficiency has already been proved. In particular, the pipe ends do not need to be machined, but can be used as they are. If there are no severe rock pockets, or rust or rock pockets are minor, its functions remain intact and in perfect condition.



Piping in mechanical device sectors that experience vibrations

Widely used as intake and discharge piping for clean water, seawater and cooling water, and as pipes for compressed air, powder, chemicals, coal, etc. If the pipe is blocked due to wastewater and intake and discharge is prevented, the coupling can be detached again, cleaned and reassembled, thereby minimizing the hassle, cost, and manpower.

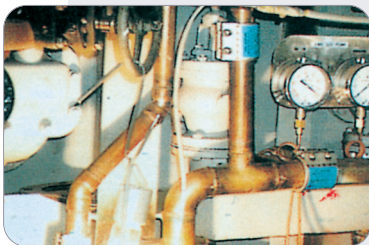

For industrial plants

As it reduces stationary vibrations and noise occurring from continuous vibration and from the mechanical parts of a rotating machine or power units by more than 60%, strains on the accessory equipment or gauges are reduced.

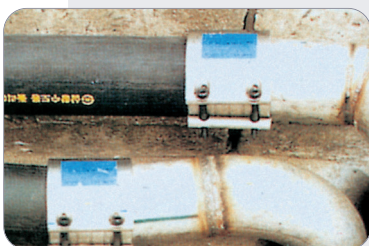

Applied to shipbuilding companies

It is used for connecting PVC pipes with stainless steel pipes made of entirely different materials, and for coupling heterogeneous pipes such as stainless steel pipes and cast iron pipes. Even though a deviation of about 10° occurs, air tightness is definitely maintained.

APPLICATION OF PIPE COUPLING

Applications of the product

- Installed in the indoor and outdoor pipelines of factories, general buildings, and in insulated dual pipes (district heating works).
- Used for installing/repairing new pipes in commercial ships and battleship engines and decks, and for making repairs to the pipes of vessels in operation.
- Used to connect water and sewage pipes, drainpipes, firefighting pipes, water supply pipes, agricultural water supply pipes, conduits, hume pipes and PVC, FRP pipes, etc.
- Used for installing water pipes and drainpipes in nuclear, thermal, and hydroelectric power plants.
- Used for installing subway structures and for pipes buried underground and underwater.
- Used for installing oil pipelines in refineries and gas pipes buried underground.
- Used for installing equipment pipes, transmission pipes in refrigeration plants, and others.

Overview of Application Scope

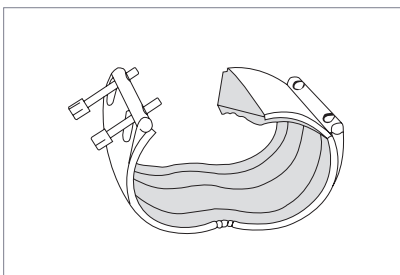

Easy use for repair of indoor and outdoor piping in new or old buildings.

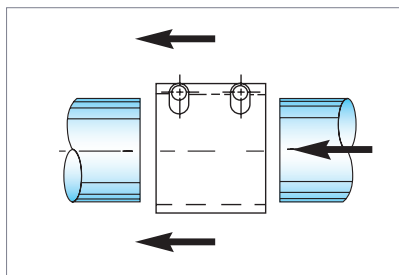

No need for special tools. It has the function of completely absorbing external impacts and vibrations.

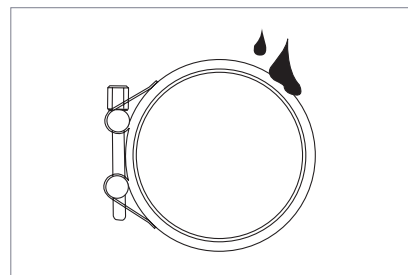

Made of strong corrosion-resistant stainless steel 304 materials, it prevents corrosion even in contact with corrosive wastewater or chemicals from the outside.

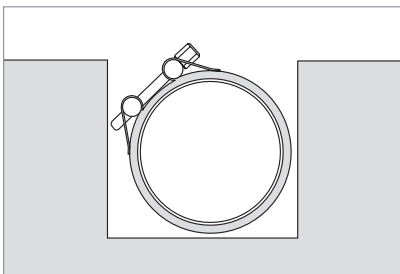

Designed and manufactured by an efficient construction method for use even in confined spaces, its cost efficiency is guaranteed.

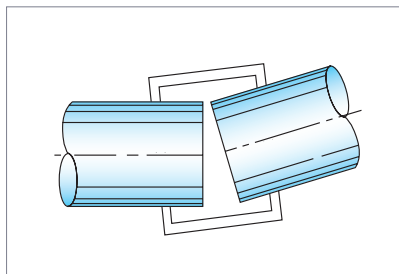

The center torsion is allowed up to 5° on both sides.

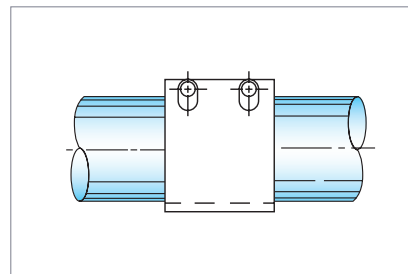

The contents remain airtight even when outside impacts are applied to the front, rear, left and right instantaneously or in succession.

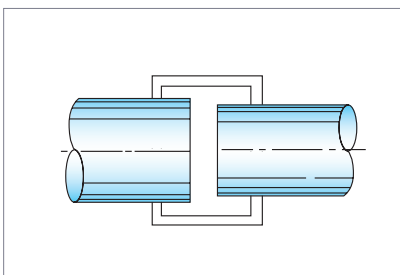

Absolutely no problems occur even if the pipe outer diameter (diameter) is either larger or smaller by about 2%.

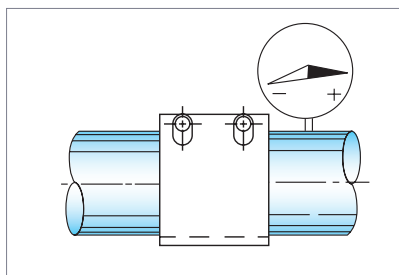

Despite the instantaneous inside pressure inflow or vacuum state, its function remains in perfect condition.

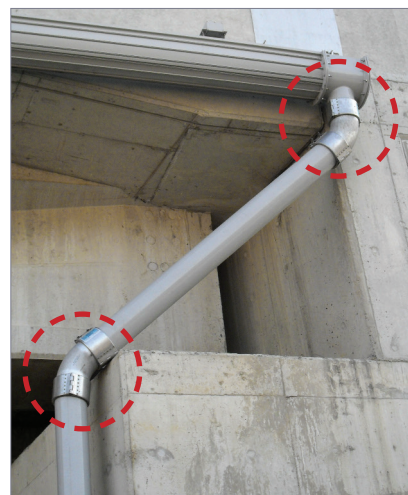

Drainage Line

Youngnam Metal's multipurpose PIPE COUPLINGS will provide the most efficiency for your design and installation in terms of its use and economy and will enhance your design quality.

OPERATING PRINCIPLE AND INSTALLATION

Excellence of this product

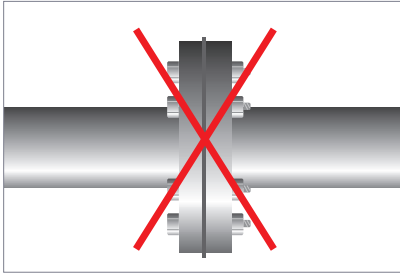

GRIP RING PIPE COUPLING is structurally designed to securely fasten the pipe under high pressure, and may be used for any type of piping. It is the most practical and efficient pipe coupling process ever developed, and has eliminated the hassle of existing processes, such as the flange welding, socket and union installation processes.

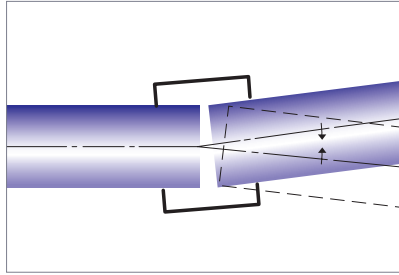

GRIP RING PIPE COUPLING can be installed up to a maximum allowable angle of 5° on both axes. GRIP RING LONG SIZE (GR-L) can be installed up to 3° even if the center is affected by torsion on either side.

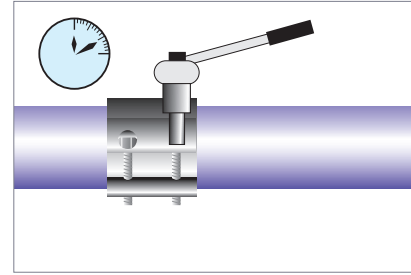

GRIP RING PIPE COUPLING can be installed by anyone, anytime and anywhere, with the utmost ease. Installation in one place requires only 10 minutes.

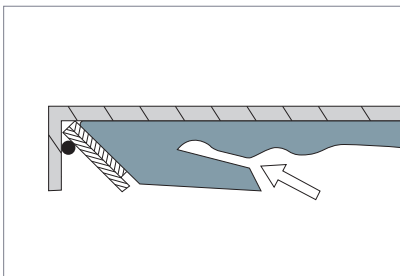

GRIP RING PIPE COUPLING can guarantee not only semi-permanent use, but also perfectly and securely fastens the pipe under pressure, since the grip ring is designed and fitted at 45° , as shown below.

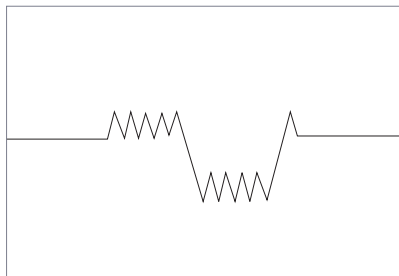

With a specially structured inner sealing, airtightness is perfect. Simultaneous vibration and continuous noise are reduced by over 60%, and instantaneous vibration, stationary vibration, and one-side vibration are absorbed as well.

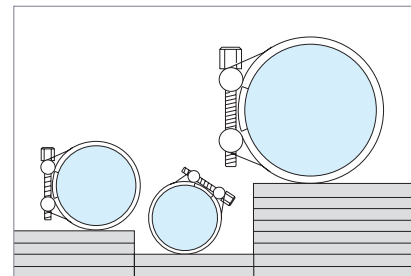

Space use is minimized through construction in concrete structures, and in other narrow spaces such as the pit space in an apartment, and the construction process is excellent in the face of chronic problems of stagnating wastewater, rainwater, etc. The product, with its simple design, will be an integral part of your piping technology.

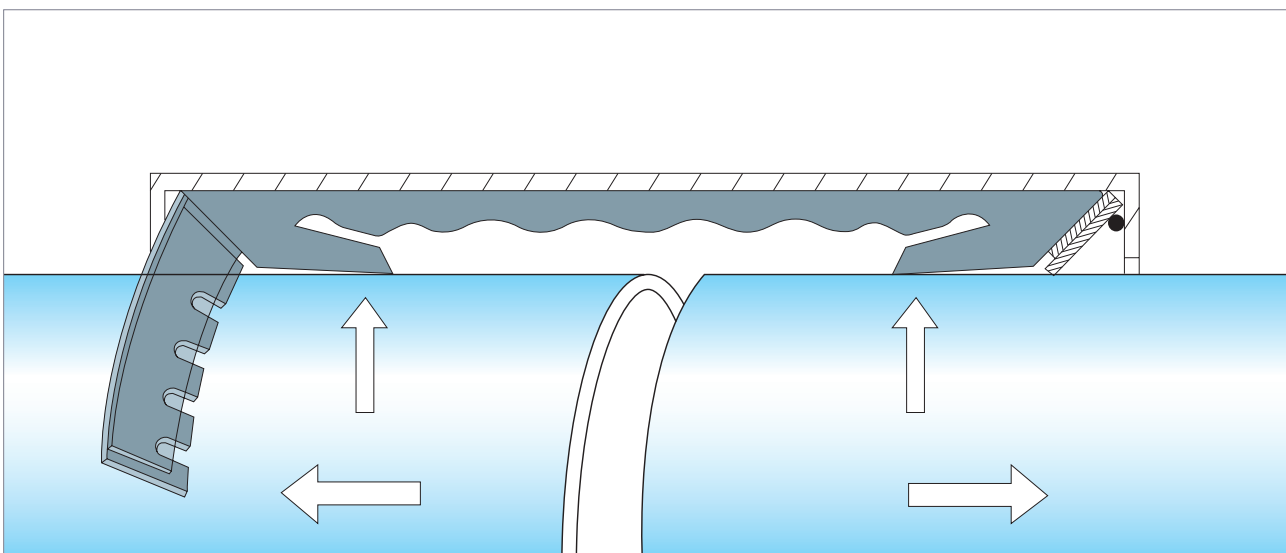

Large YN Pipe Couplings Ø3120mm

Ø3120mm for ocean bed connection



Large size pipe couplings



Installing prepare



Installation of ocean bed blocks

YN-PIPE COUPLING FROM MANUFACTURING TO SITE



▲ Busan New Port Container Terminal Construction Work



▲ Repair work for pipes replaced underground



▲ 48" (1,200A) YN MF-RL Canadian power plant cooling line



▲ UK: buried water supply pipes



▲ Netherland desalination treatment facilities



▲ Spain: water purification facilities



▲ UK: district heating work



▲ Canada: water purification facility



▲ U.S.: nuclear power plant



▲ U.S.: sewerage repair work

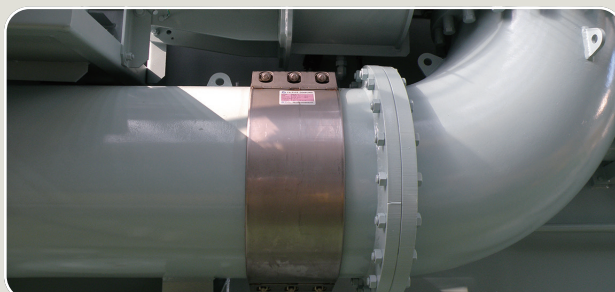

▲ Engine Air Line



▲ PVC + Steel Pipe Connection

A company that contributes to society with advanced technological capability - YOUNGNAM METAL

PIPE COUPLING APPLICATION TECHNOLOGY

Application for Pipe



▲ Underground drainage repair(Maintenance) works

LARGE PIPE COUPLING Installation Record and Connection Method



Wolsung nuclear power plant



Jinhae Wung-dong sewage treatment plant construction

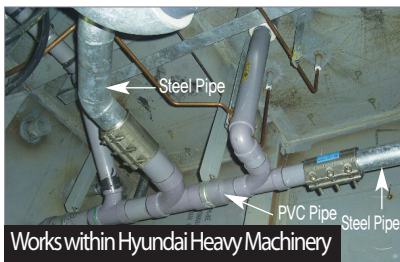

Works within Hyundai Heavy Machinery



Seawater supply line

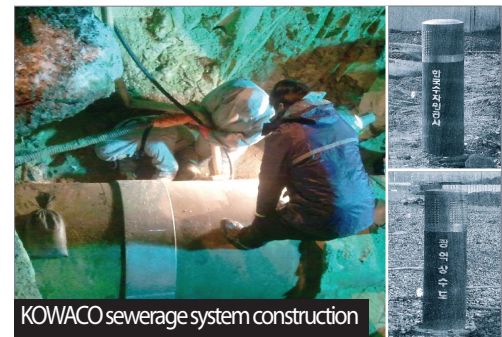

KOWACO sewerage system construction

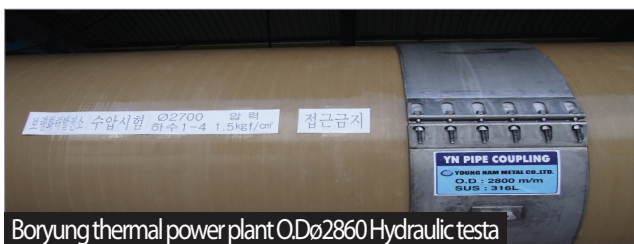

Boryung thermal power plant O.Dø2860 Hydraulic testa



Completion of 4m pipe replacement/repair for 400A sewer pipe

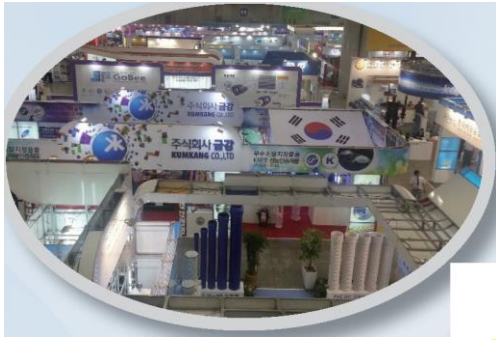

Exhibition Participation



World wide Distributors



YOUNGNAM METAL CO.,LTD

12-3 Jillye-ro 74beon-gil, Jillye-myeon, Gimhae-si, Gyeongsangnam-do, 50874 Korea

URL : www.yncoupling.com

MULTIEXPANSION S.L

Recinto Interior Zona Franca de Cádiz--Edificio Heracles - C/Andorra Nave 16L

11011 Cádiz - Spain

contacto@multiexpansion.es www.multiexpansion.com

