

174

CAMPANAS LED
CAMPÂNULA LED



125lm/W

CAMPANA INDUSTRIAL LED *SILVER*
CAMPÂNULA LED *SILVER*

LUMILEDS
The Brighter Choice
LUXEON 3030 2d

3 ANOS GARANTIA

100W

9610006CW 5700 K 12500 Lm
9610006NW 4000 K 12300 Lm

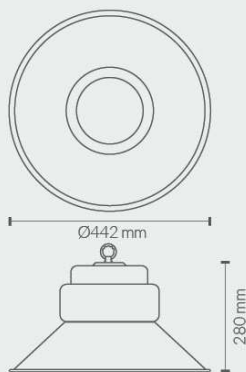

PROTECCIONES DEL DRIVER
PROTEÇÕES DO DRIVER

OVP	Protección contra sobretensión Proteção contra sobretensão
SCP	Protección contra cortocircuitos Proteção contra curto-circuito
OPP	Protección de sobrecarga Proteção de sobrecarga
OTP	Protección contra sobrecalentamiento Proteção contra superaquecimento





125lm/W



CAMPANA INDUSTRIAL LED *SILVER*
CAMPÂNULA LED *SILVER*



PROTECCIONES DEL DRIVER	
PROTEÇÕES DO DRIVER	
OVP	Protección contra sobretensión <i>Proteção contra sobretensão</i>
SCP	Protección contra cortocircuitos <i>Proteção contra curto-circuito</i>
OPP	Protección de sobrecarga <i>Proteção de sobrecarga</i>
OTP	Protección contra sobrecalentamiento <i>Proteção contra superaquecimento</i>

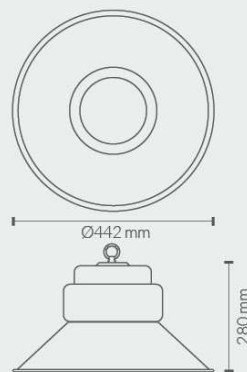

150W

9615006CW	5700 K	18750 Lm
9615006NW	4500 K	18450 Lm



CAMPANAS LED

CAMPÂNULA LED



CAMPANA INDUSTRIAL LED *SILVER*

CAMPÂNULA LED *SILVER*

LUMILEDS
The Brighter Choice
LUXEON 3030 2d

125lm/W

3 ANOS
Garantía

200W

9620006CW
9620006NW

5700 K 25000 Lm
4500 K 24600 Lm

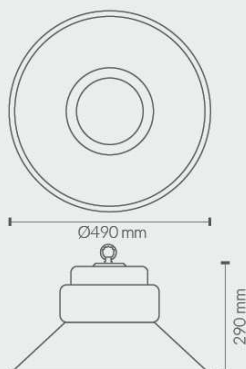

PROTECCIONES DEL DRIVER PROTEÇÕES DO DRIVER

OVP	Protección contra sobretensión <i>Proteção contra sobretensão</i>
SCP	Protección contra cortocircuitos <i>Proteção contra curto-circuito</i>
OPP	Protección de sobrecarga <i>Proteção de sobrecarga</i>
OTP	Protección contra sobrecalentamiento <i>Proteção contra superaquecimento</i>





135lm/W

DISEÑADO Y
ENSAMBLADO
ESPAÑA

5 AÑOS
Garantía

CAMPANA LED UFO *PLUS*
CAMPÂNULA LED UFO *PLUS*

110V 240V
MULTITENSIÓN

LUMILEDS
The Brighter Choice
LUXEON 3030 2d

PROTECCIONES DEL DRIVER
PROTEÇÕES DO DRIVER

- OVP Protección contra sobretensión
Proteção contra sobretensão
- SCP Protección contra cortocircuitos
Proteção contra curto-circuito
- OPP Protección de sobrecarga
Proteção de sobrecarga
- OTP Protección contra sobrecalentamiento
Proteção contra superaquecimento

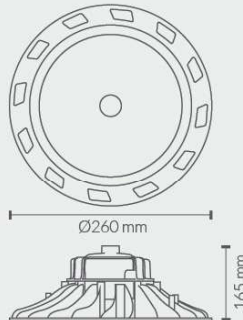

100W



9610001209CW 5700 K 13500 Lm
9610001209NW 4000 K 13300 Lm



9610001212CW 5700 K 13500 Lm
9610001212NW 4000 K 13300 Lm



CAMPANAS LED

CAMPÂNULA LED



CAMPANA LED UFO *PLUS* CAMPÂNULA LED UFO *PLUS*

DISEÑADO Y
ENSAMBLADO
ESPAÑA

135lm/W

5 ANOS
Garantía

LUMILEDS
The Brighter Choice
LUXEON 3030 2d

110V 240V
MULTITENSIÓN

150W



9615001209CW 5700 K 20250 Lm
9615001209NW 4000 K 19950 Lm



9615001212CW 5700 K 20250 Lm
9615001212NW 4000 K 19950 Lm

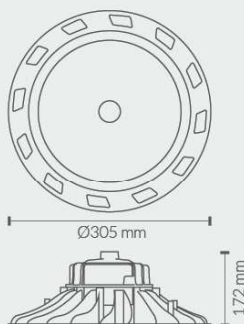

PROTECCIONES DEL DRIVER
PROTEÇÕES DO DRIVER

- OVP** Protección contra sobretensión
Proteção contra sobretensão
- SCP** Protección contra cortocircuitos
Proteção contra curto-circuito
- OPP** Protección de sobrecarga
Proteção de sobrecarga
- OTP** Protección contra sobrecalentamiento
Proteção contra superaquecimento



135lm/W

DISEÑADO Y
ENSAMBLADO
ESPAÑA

5 AÑOS
Garantía

CAMPANA LED UFO *PLUS*
CAMPÂNULA LED UFO *PLUS*

110V 240V
MULTITENSIÓN

LUMILEDS
The Brighter Choice
LUXEON 3030 2d

PROTECCIONES DEL DRIVER PROTEÇÕES DO DRIVER	
OVP	Protección contra sobretensión <i>Proteção contra sobretensão</i>
SCP	Protección contra cortocircuitos <i>Proteção contra curto-circuito</i>
OPP	Protección de sobrecarga <i>Proteção de sobrecarga</i>
OTP	Protección contra sobrecalentamiento <i>Proteção contra superaquecimento</i>

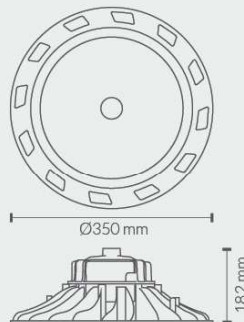

200W

9620001209CW 5700 K 27000 Lm
9620001209NW 4000 K 26600 Lm



9620001212CW 5700 K 27000 Lm
9620001212NW 4000 K 26600 Lm

85/265
VAC

SMD
X320

CRI
>80

PF
0,9

4KV

-20°/50°

45000
HRS

35000
ON/OFF

IP
65

IK
08

ALUMINIO

3,30 kg

CAMPANAS LED

CAMPÂNULA LED



CAMPANA LED UFO PLUS CAMPÂNULA LED UFO PLUS

 DISEÑADO Y
ENSAMBLADO
ESPAÑA

135lm/W

5 AÑOS
Garantía

LUMILEDS
The Brighter Choice
LUXEON 3030 2d

110V 240V
MULTITENSIÓN

240W



9624001209CW 5700 K 32400 Lm
9624001209NW 4000 K 31920 Lm



9624001212CW 5700 K 32400 Lm
9624001212NW 4000 K 31920 Lm

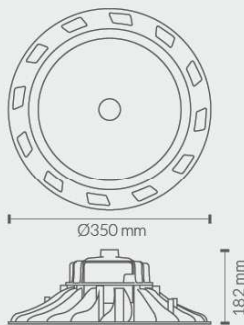

PROTECCIONES DEL DRIVER
PROTEÇÕES DO DRIVER

- OVP Protección contra sobretensión / Proteção contra sobretensão
- SCP Protección contra cortocircuitos / Proteção contra curto-circuito
- OPP Protección de sobrecarga / Proteção de sobrecarga
- OTP Protección contra sobrecalentamiento / Proteção contra superaquecimento

- 85/265 VAC
- SMD X320
- CRI >80
- PF 0,9
- 4KV
- 20°/50°
- 45000 HRS
- 35000 ON/OFF
- IP 65
- IK 08
- ALUMINIO
- 3,30 kg



145lm/W

DISEÑADO Y ENSAMBLADO ESPAÑA

5 AÑOS GARANTÍA

PROTECCIONES DEL DRIVER
PROTEÇÕES DO DRIVER



- OVP Protección contra sobretensión
Proteção contra sobretensão
- SCP Protección contra cortocircuitos
Proteção contra curto-circuito
- OPP Protección de sobrecarga
Proteção de sobrecarga
- OTP Protección contra sobrecalentamiento
Proteção contra superaquecimento

CAMPANA LED UFO **MAX**
CAMPÂNULA LED UFO **MAX**



100W

9610001CW 5700 K 14500 Lm
9610001NW 4000 K 14300 Lm

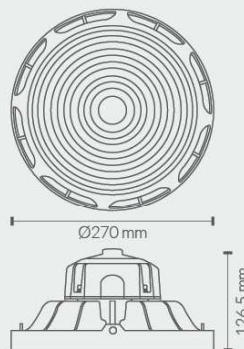

CAMPANAS LED

CAMPÂNULA LED



CAMPANA LED UFO *MAX* CAMPÂNULA LED UFO *MAX*

LUMILEDS
The Brighter Choice
LUXEON 3030 2d

MW
MEAN WELL

110V 240V
MULTITENSIÓN

150W

9615001CW	5700 K	21750 Lm
9615001NW	4000 K	21450 Lm

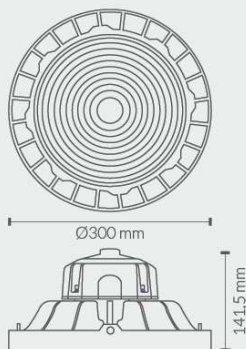

 DISEÑADO Y ENSAMBLADO EN ESPAÑA

145lm/W

5 AÑOS GARANTÍA

PROTECCIONES DEL DRIVER PROTEÇÕES DO DRIVER

MW
MEAN WELL

- OVP Protección contra sobretensión
Proteção contra sobretensão
- SCP Protección contra cortocircuitos
Proteção contra curto-circuito
- OPP Protección de sobrecarga
Proteção de sobrecarga
- OTP Protección contra sobrecalentamiento
Proteção contra superaquecimento



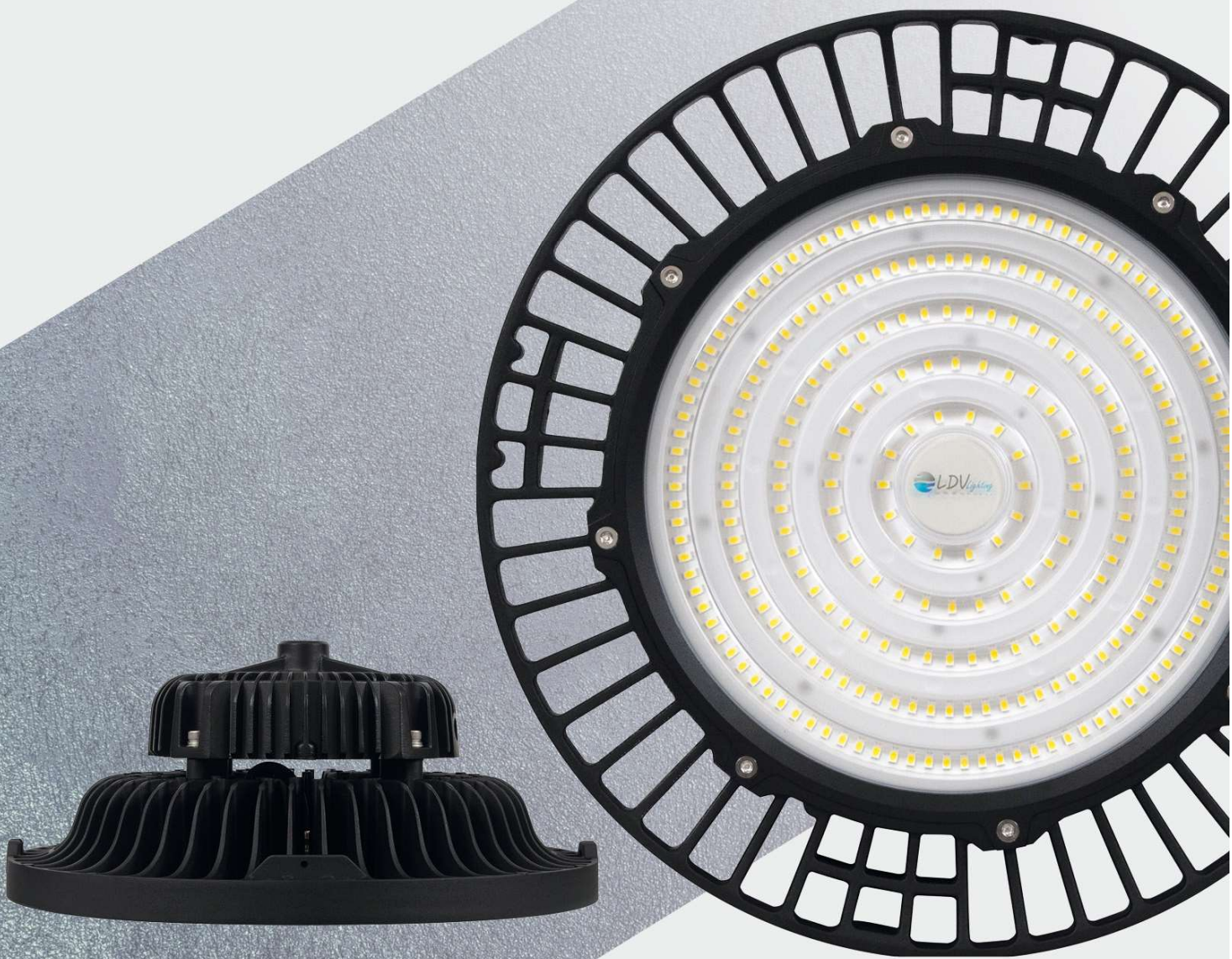

145lm/W

DESIGNADO Y
ENSAMBLADO
EN
ESPAÑA

5
AÑOS
GARANTÍA

CAMPANA LED UFO *MAX*
CAMPÂNULA LED UFO *MAX*

110V 240V
MULTITENSIÓN

MW
MEAN WELL

LUMILEDS
The Brighter Choice
LUXEON 3030 2d

200W

9620001CW
9620001NW

5700 K
4000 K

29000 Lm
28600 Lm

PROTECCIONES DEL DRIVER
PROTEÇÕES DO DRIVER

MW
MEAN WELL

- OVP Protección contra sobretensión
Proteção contra sobretensão
- SCP Protección contra cortocircuitos
Proteção contra curto-circuito
- OPP Protección de sobrecarga
Proteção de sobrecarga
- OTP Protección contra sobrecalentamiento
Proteção contra superaquecimento

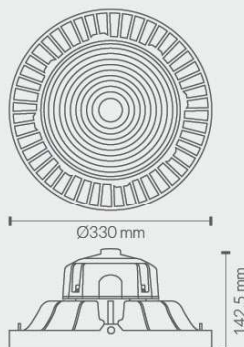

CAMPANAS LED

CAMPÂNULA LED



CAMPANA LED UFO *MAX* CAMPÂNULA LED UFO *MAX*

 DISEÑADO Y ENSAMBLADO EN ESPAÑA

145lm/W

LUMILEDS
The Brighter Choice
LUXEON 3030 2d

MW
MEAN WELL

110V 240V
MULTITENSIÓN

5 ANOS
Garantía

240W

9624001CW 5700 K 34800 Lm
9624001NW 4000 K 34320 Lm

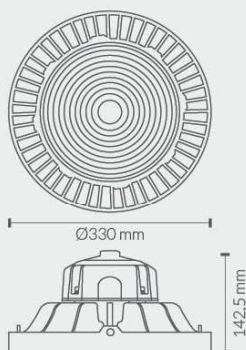

PROTECCIONES DEL DRIVER PROTEÇÕES DO DRIVER

MW
MEAN WELL

- OVP Protección contra sobretensión
Proteção contra sobretensão
- SCP Protección contra cortocircuitos
Proteção contra curto-circuito
- OPP Protección de sobrecarga
Proteção de sobrecarga
- OTP Protección contra sobrecalentamiento
Proteção contra superaquecimento



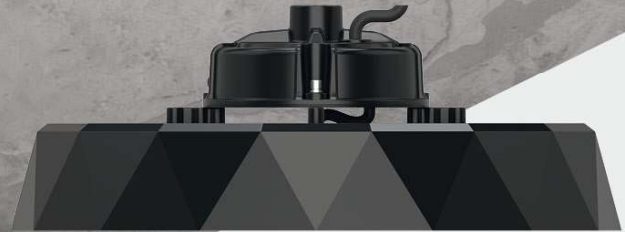

165lm/W



CAMPANA LED UFO *ASTRAL* REGULABLE
0-10v/PWM/ Resistor



DISEÑADO Y
ENSAMBLADO
ESPANA

CAMPÂNULA LED UFO *ASTRAL* REGULÁVEL
0-10v/PWM/Resistor



100W



9610001357CW	5700 K	16500 Lm
9610001350CW	5000 K	16300 Lm
9610001340NW	4000 K	16100 Lm

100W

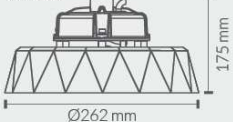

150W

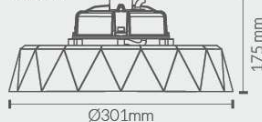

200W
240W



150W



9615001357CW	5700 K	24750 Lm
9615001350CW	5000 K	24450 Lm
9615001340NW	4000 K	24150 Lm



200W



9620001357CW	5700 K	33000 Lm
9620001350CW	5000 K	32600 Lm
9620001340NW	4000 K	32200 Lm



240W



9624001357CW	5700 K	39600 Lm
9624001350CW	5000 K	39120 Lm
9624001340NW	4000 K	38640 Lm

PROTECCIONES DEL DRIVER
PROTEÇÕES DO DRIVER



OVP	Protección contra sobretensión <i>Proteção contra sobretensão</i>
SCP	Protección contra cortocircuitos <i>Proteção contra curto-circuito</i>
OPP	Protección de sobrecarga <i>Proteção de sobrecarga</i>
OTP	Protección contra sobrecalentamiento <i>Proteção contra superaquecimento</i>



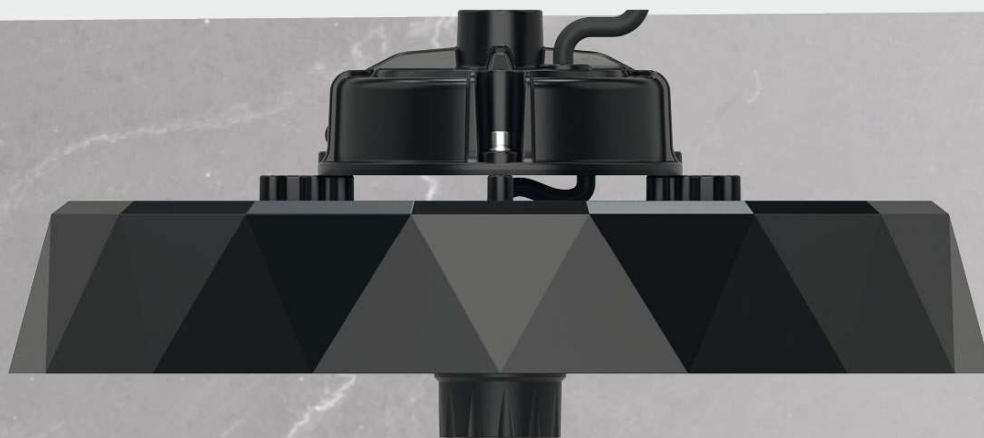

CAMPANA LED UFO *ASTRAL* REGULABLE C/SENSOR Y FUNCIONAMIENTO ON/STAND-BY/OFF

CAMPÂNULA LED UFO *ASTRAL* C/ SENSOR OPERAÇÃO ON/STAND-BY/OFF

165lm/W



DISEÑADO Y
ENSAMBLADO
ESPAÑA

100W

9610001357SCW	5700 K	16500 Lm
9610001350SCW	5000 K	16300 Lm
9610001340SNW	4000 K	16100 Lm

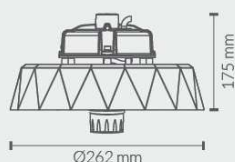

960005
MANDO DE CONTROL
REMOTO HD05R
COMANDO DE CONTROLE
REMOTO HD05R

PROTECCIONES DEL DRIVER

PROTEÇÕES DO DRIVER

OVP	Protección contra sobretensión Proteção contra sobretensão
SCP	Protección contra cortocircuitos Proteção contra curto-circuito
OPP	Protección de sobrecarga Proteção de sobrecarga
OTP	Protección contra sobrecalentamiento Proteção contra superaquecimento



HAISEN[®] ESPECIFICACIONES SENSOR



SENSOR
HD06VCRH 7B

Tipo de Sensor Tipo de Sensor	Microondas Microondas	Tiempo de encendido Tempo de ignição	5s, 30s, 1min, 3min, 5min, 10min, 20min, 30min.
Marca Marca	HAISEN	Regulación de Luminosidad en stand by Controlo de luminosidade em stand-by	10%, 20%, 30%, 50%
Modelo Modelo	HD06VCRH 7B	Tiempo de encendido en stand by Tempo de ignição	0s, 1min, 30min, infinito.
Modo de Trabajo Modo de trabalho	Función on/off Função liga / desliga Funcion on/stand-by Função On / Stand-by Funcion on/stand-by/off Função On / Stand-by / Off	Área de detección Área de deteção	100%, 75%, 50%, 25%
Opción de configuración Opção de configuração	Si Sim	Sensor de luminosidad Sensor de luminosidade	2lux, 10lux, 30lux, 50lux, 80lux, 120lux, deshabilitado (desativado)
Sistema de Control Sistema de controlo	Control remoto Controlo remoto	Rango de detección Faixa de deteção	D12mts (montaje en techo) D12mts (montagem no teto)
Regulación de Luminosidad Controlo de luminosidade	0% (0.5V) - 100% (10V)	Altura de montaje Altura de montagem	max. 10mts





165lm/W



DISEÑADO Y ENSAMBLADO ESPAÑA

CAMPANA LED UFO *ASTRAL* REGULABLE C/SENSOR Y FUNCIONAMIENTO ON/STAND-BY/OFF

CAMPÂNULA LED UFO *ASTRAL* C/ SENSOR OPERAÇÃO ON/STAND-BY/OFF



PROTECCIONES DEL DRIVER
PROTEÇÕES DO DRIVER



- OVP Protección contra sobretensión
Proteção contra sobretensão
- SCP Protección contra cortocircuitos
Proteção contra curto-circuito
- OPP Protección de sobrecarga
Proteção de sobrecarga
- OTP Protección contra sobrecalentamiento
Proteção contra superaquecimento



960005
MANDO DE CONTROL REMOTO HD05R
COMANDO DE CONTROLE REMOTO HD05R

150W

- 9615001357SCW 5700 K 24750 Lm
- 9615001350SCW 5000 K 24450 Lm
- 9615001340SNW 4000 K 24150 Lm

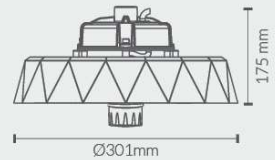

HAISEN® ESPECIFICACIONES SENSOR
ESPECIFICAÇÕES DO SENSOR

Tipo de Sensor <i>Tipo de Sensor</i>	Microondas <i>Microondas</i>	Tiempo de encendido <i>Tempo de ignição</i>	5s, 30s, 1min, 3min, 5min, 10min, 20min, 30min.
Marca <i>Marca</i>	HAISEN	Regulación de Luminosidad en stand by <i>Controlo de luminosidade em stand-by</i>	10%, 20%, 30%, 50%
Modelo <i>Modelo</i>	HD06VCRH 7B	Tiempo de encendido en stand by <i>Tempo de ignição</i>	0s, 1min, 30min, infinito.
Modo de Trabajo <i>Modo de trabalho</i>	Función on/off <i>Função liga / desliga</i> Funcion on/stand-by <i>Função On / Stand-by</i> Funcion on/stand-by/off <i>Função On / Stand-by / Off</i>	Área de detección <i>Área de detecção</i>	100%, 75%, 50%, 25%
Opción de configuración <i>Opção de configuração</i>	Si <i>Sim</i>	Sensor de luminosidad <i>Sensor de luminosidade</i>	2lux, 10lux, 30lux, 50lux, 80lux, 120lux, deshabilitado (<i>desativado</i>)
Sistema de Control <i>Sistema de controlo</i>	Control remoto <i>Controle remoto</i>	Rango de detección <i>Faixa de detecção</i>	D12mts (montaje en techo) <i>D12mts (montagem no teto)</i>
Regulación de Luminosidad <i>Controlo de luminosidade</i>	0% (0.5V) - 100% (10V)	Altura de montaje <i>Altura de montagem</i>	max. 10mts





CAMPANA LED UFO *ASTRAL* REGULABLE
C/SENSOR Y FUNCIONAMIENTO
ON/STAND-BY/OFF

CAMPÂNULA LED UFO *ASTRAL* C/ SENSOR OPERAÇÃO ON/STAND-BY/OFF

165lm/W



DISEÑADO Y
ENSAMBLADO
ESPANA

200W

9620001357SCW	5700 K	33000 Lm
9620001350SCW	5000 K	32600 Lm
9620001340SNW	4000 K	32200 Lm

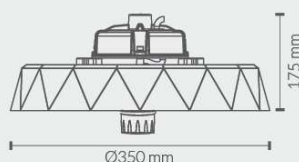

960005
MANDO DE CONTROL
REMOTO HD05R
COMANDO DE CONTROLE
REMOTO HD05R

PROTECCIONES DEL DRIVER

PROTEÇÕES DO DRIVER

OVP	Protección contra sobretensión Proteção contra sobretensão
SCP	Protección contra cortocircuitos Proteção contra curto-circuito
OPP	Protección de sobrecarga Proteção de sobrecarga
OTP	Protección contra sobrecalentamiento Proteção contra superaquecimento



ESPECIFICACIONES SENSOR

ESPECIFICAÇÕES DO SENSOR



Tipo de Sensor

Tipo de Sensor

Marca

Marca

Modelo

Modelo

Modo de Trabajo

Modo de trabalho

Opción de configuración

Opção de configuração

Sistema de Control

Sistema de controle

Regulación de Luminosidad

Controlo de luminosidade

Microondas

Microondas

HAISEN

HD06VCRH 7B

Función on/off

Função liga / desliga

Funcion on/stand-by

Função On / Stand-by

Funcion on/stand-by/off

Função On / Stand-by / Off

Si

Sim

Control remoto

Controlo remoto

0% (0.5V) - 100% (10V)

Tiempo de encendido

Tempo de ignição

5s, 30s, 1min, 3min,
5min, 10min, 20min,
30min.

Regulación de Luminosidad en stand by

Controlo de luminosidade em stand-by

10%, 20%, 30%, 50%

Tiempo de encendido en stand by

Tempo de ignição

0s, 1min, 30min, infinito.

Área de detección

Área de detecção

100%, 75%, 50%, 25%

Sensor de luminosidad

Sensor de luminosidade

2lux, 10lux, 30lux, 50lux,
80lux, 120lux,
deshabilitado (desativado)

Rango de detección

Faixa de detecção

D12mts (montaje en techo)
D12mts (montagem no teto)

Altura de montaje

Altura de montagem

max. 10mts





165lm/W



DISEÑADO Y ENSAMBLADO ESPAÑA

CAMPANA LED UFO *ASTRAL* REGULABLE
C/SENSOR Y FUNCIONAMIENTO
ON/STAND-BY/OFF

CAMPÂNULA LED UFO *ASTRAL* C/ SENSOR OPERAÇÃO ON/STAND-BY/OFF



PROTECCIONES DEL DRIVER
PROTEÇÕES DO DRIVER



OVP	Protección contra sobretensión Proteção contra sobretensão
SCP	Protección contra cortocircuitos Proteção contra curto-circuito
OPP	Protección de sobrecarga Proteção de sobrecarga
OTP	Protección contra sobrecalentamiento Proteção contra superaquecimento



960005
MANDO DE CONTROL
REMOTO HD05R
COMANDO DE CONTROLE
REMOTO HD05R

240W

9624001357SCW	5700 K	39600 Lm
9624001350SCW	5000 K	39120 Lm
9624001340SNW	4000 K	38640 Lm

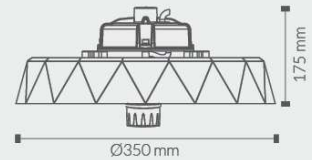

HAISEN ESPECIFICACIONES SENSOR
ESPECIFICAÇÕES DO SENSOR

Tipo de Sensor Tipo de Sensor	Microondas Microondas	Tiempo de encendido Tempo de ignição	5s, 30s, 1min, 3min, 5min, 10min, 20min, 30min.
Marca Marca	HAISEN	Regulación de Luminosidad en stand by Controlo de luminosidade em stand-by	10%, 20%, 30%, 50%
Modelo Modelo	HD06VCRH 7B	Tiempo de encendido en stand by Tempo de ignição	0s, 1min, 30min, infinito.
Modo de Trabajo Modo de trabalho	Función on/off Função liga / desliga Funcion on/stand-by Função On / Stand-by Funcion on/stand-by/off Função On / Stand-by / Off	Área de detección Área de detecção	100%, 75%, 50%, 25%
Opción de configuración Opção de configuração	Si Sim	Sensor de luminosidad Sensor de luminosidade	2lux, 10lux, 30lux, 50lux, 80lux, 120lux, deshabilitado (desativado)
Sistema de Control Sistema de controlo	Control remoto Controlo remoto	Rango de detección Faixa de detecção	D12mts (montaje en techo) D12mts (montagem no teto)
Regulación de Luminosidad Controlo de luminosidade	0% (0.5V) - 100% (10V)	Altura de montaje Altura de montagem	max. 10mts



ACCESORIOS UFO *MAX*
ACESSÓRIOS UFO *MAX*

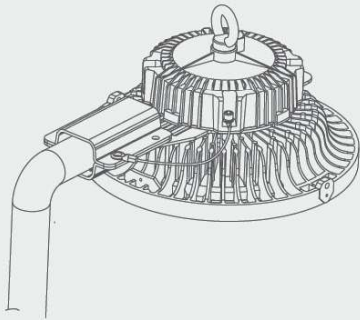

ADAPTADOR SOPORTE BRAZO DE COLUMNA O BÁCULOS
ADAPTADOR DE SUPORTE PARA BRAÇO DE COLUNA OU HASTE

960000

Modo de instalación: COLUMNA/ BÁCULO D50-65mm

Modo de instalação: COLUNA / HASTE D50-65mm

SOPORTE LIRA PARA UFO MAX
SUPORTE DE LIRA PARA UFO

960001 - 100W

Modo de instalación: PARED / TECHO

Modo de instalação: PAREDE / TETO



960002 - 150W

Modo de instalación: PARED / TECHO

Modo de instalação: PAREDE / TETO

960003 - 200W / 240W

Modo de instalación: PARED / TECHO

Modo de instalação: PAREDE / TETO

Lira con goniómetro

Lira com goniômetro



ÂNGULO 15°
ÂNGULO 15°



ÂNGULO 60°
ÂNGULO 60°



ÂNGULO 90°
ÂNGULO 90°



LUMINARIAS VIALES
LUMINÁRIAS PARA EXTERIOR